



Dual, 2.2MHz, Automotive Synchronous Buck Converter with 80V Load-Dump Protection

MAX5099

General Description

The MAX5099 offers a dual-output, high-switching-frequency DC-DC buck converter with an integrated high-side switch. The MAX5099 integrates two low-side MOSFET drivers to allow each converter to drive an external synchronous-rectifier MOSFET. Converter 1 delivers up to 2A output current, and converter 2 can deliver up to 1A of output current. The MAX5099 integrates load-dump protection circuitry that is capable of handling load-dump transients up to 80V for automotive applications. The load-dump protection circuit utilizes an internal charge pump to drive the gate of an external n-channel MOSFET. When an overvoltage or load-dump condition occurs, the series protection MOSFET absorbs the high voltage transient to prevent damage to lower voltage components.

The DC-DC converter operates over a wide 4.5V to 19V operating voltage range. The MAX5099 operates 180° out-of-phase with an adjustable switching frequency to minimize external components while allowing the ability to make trade-offs between the size, efficiency, and cost. The high switching frequency also allows these devices to operate outside the AM band for automotive applications. These regulators can be protected against high voltage transients such as a load-dump condition by using the integrated overvoltage controller.

This device utilizes voltage-mode control for stable operation and external compensation, so that the loop gain is tailored to optimize component selection and transient response. The MAX5099 has a maximum duty cycle of 92.5% and is synchronized to an external clock fed at the SYNC input.

Additional features include internal digital soft-start, individual enable for each DC-DC regulator (EN1 and EN2), open-drain power-good outputs (PGOOD1 and PGOOD2), and shutdown input (ON/OFF).

Other features of the MAX5099 include overvoltage protection and short-circuit (hiccup current limit) and thermal protection. The MAX5099 is available in a thermally enhanced, exposed pad 5mm x 5mm, 32-pin TQFN package and operates over the automotive -40°C to +125°C temperature range.

Applications

Automotive AM/FM Radio Power Supply
Automotive Instrument Cluster Display

Features

- ◆ Wide 4.5V to 5.5V or 5.2V to 19V Input Voltage Range with 80V Load-Dump Protection
- ◆ Dual-Output DC-DC Converter with Integrated Power MOSFETs
- ◆ Adjustable Outputs from 0.8V to 0.9V_{IN}
- ◆ Output Current Capability Up to 2A and 1A
- ◆ Switching Frequency Programmable from 200kHz to 2.2MHz
- ◆ Synchronization Input (SYNC)
- ◆ Individual Converter Enable Input and Power-Good Output
- ◆ Low-I_q (7μA) Standby Current (ON/OFF)
- ◆ Internal Digital Soft-Start and Soft-Stop
- ◆ Short-Circuit Protection on Outputs and Maximum Duty-Cycle Limit
- ◆ Overvoltage Protection on Outputs with Auto Restart
- ◆ Thermal Shutdown
- ◆ Thermally Enhanced 32-Pin TQFN Package Dissipates Up to 2.7W at +70°C

Ordering Information

PART	TEMP RANGE	PIN-PACKAGE
MAX5099ATJ+	-40°C to +125°C	32 TQFN-EP*

+Denotes a lead-free package.

*EP = Exposed pad.

Pin Configuration appears at end of data sheet.

Dual, 2.2MHz, Automotive Synchronous Buck Converter with 80V Load-Dump Protection

ABSOLUTE MAXIMUM RATINGS

V+ to SGND	-0.3V to +25V	OSC, FSEL_1, COMP_, SYNC,
V+ to IN_HIGH	-19V to +6V	FB_ to SGND
IN_HIGH to SGND	-0.3V to +19V	DL_ to PGND
IN_HIGH Maximum Input Current	60mA	SOURCE1, DRAIN1 Peak Current
BYPASS to SGND	-0.3V to +2.5V	SOURCE2, DRAIN2 Peak Current
GATE to V+	-0.3V to +12V	V_L, BYPASS to
GATE to SGND	-0.3V to +36V	SGND Short Circuit
SGND to PGND	-0.3V to +0.3V	Continuous, Internally Limited
V_L to SGND	-0.3V to the Lower of +6V or (V+ + 0.3V)	Continuous Power Dissipation (T _A = +70°C)
VDRV to SGND	-0.3V to +6V	32-Pin TQFN-EP (derate 34.5mW/°C above +70°C)
BST1/VDD1, BST2/VDD2, DRAIN_		Package Junction-to-Ambient
PGOOD_ to SGND	-0.3V to +30V	Thermal Resistance (θ _{JA}) (Note 1)
ON/OFF to SGND	-0.3V to (IN_HIGH + 0.3V)	Package Junction-to-Case
BST1/VDD1 to SOURCE1,		Thermal Resistance (θ _{JC}) (Note 1)
BST2/VDD2 to SOURCE2	-0.3V to +6V	Operating Temperature Range
SOURCE_ to SGND	-0.6V to +25V	Storage Temperature Range
EN_ to SGND	-0.3V to +6V	Junction Temperature
		Lead Temperature (soldering, 10s)

Note 1: Package thermal resistances were obtained using the method described in JEDEC specifications. For detailed information on package thermal considerations refer to www.maxim-ic.com/thermal-tutorial.

Stresses beyond those listed under "Absolute Maximum Ratings" may cause permanent damage to the device. These are stress ratings only, and functional operation of the device at these or any other conditions beyond those indicated in the operational sections of the specifications is not implied. Exposure to absolute maximum rating conditions for extended periods may affect device reliability.

ELECTRICAL CHARACTERISTICS

(VDRV = V_L, V+ = V_L = IN_HIGH = 5.2V or V+ = IN_HIGH = 5.2V to 19V, EN_ = V_L, SYNC = GND, I_{VL} = 0mA, PGND = SGND, C_{BYPASS} = 0.22μF (low ESR), C_{VL} = 4.7μF (ceramic), C_{V+} = 1μF (low ESR), C_{IN_HIGH} = 1μF (ceramic), R_{IN_HIGH} = 3.9kΩ, R_{OSC} = 10kΩ, T_J = -40°C to +125°C, unless otherwise noted.) (Note 2)

PARAMETER	SYMBOL	CONDITIONS	MIN	TYP	MAX	UNITS
SYSTEM SPECIFICATIONS						
Input Voltage Range	V+	V+ = IN_HIGH	5.2		19	V
		V _L = V+ = IN_HIGH, Figure 6 (Note 3)	4.5		5.5	
V+ Operating Supply Current	I _Q	V _L unloaded, no switching, V _{FB} = 1V		4.2	6.0	mA
V+ Standby Supply Current	I _{V+STBY}	V _{EN} = 0V, PGOOD_ unconnected, V+ = V _{IN_HIGH} = 14V		0.75	1.1	mA
Efficiency	η	V _{OUT1} = 5V at 1.5A, V _{OUT2} = 3.3V at 0.75A, f _{sw} = 300kHz	V+ = V _L = 5.2V		86	%
			V+ = 12V		85	
			V+ = 16V		85	
OVERVOLTAGE PROTECTOR						
IN_HIGH Clamp Voltage	IN_HIGH	I _{SINK} = 10mA	19	20	21	V
IN_HIGH Clamp Load Regulation		1mA < I _{SINK} < 50mA		160		mV
IN_HIGH Supply Current	I _{IN_HIGH}	V _{EN} = V _{PGOOD} = V _{GATE} = 0V, V _{IN_HIGH} = V _{ON/OFF} = 14V		270	600	μA
IN_HIGH Standby Supply Current	I _{IN_HIGHSTBY}	V _{ON/OFF} = 0V, V _{PGOOD} = V+ = unconnected, V _{IN_HIGH} = 14V		7	9	μA
V+ to IN_HIGH Overvoltage Clamp	V _{OV}	V _{OV} = V+ - V _{IN_HIGH} , I _{GATE} = -1mA	1.20	1.85	2.50	V

Dual, 2.2MHz, Automotive Synchronous Buck Converter with 80V Load-Dump Protection

MAX5099

ELECTRICAL CHARACTERISTICS (continued)

(VDRV = V_L, V+ = V_L = IN_HIGH = 5.2V or V+ = IN_HIGH = 5.2V to 19V, EN_ = V_L, SYNC = GND, I_{VL} = 0mA, PGND = SGND, C_{BYPASS} = 0.22μF (low ESR), C_{VL} = 4.7μF (ceramic), C_{V+} = 1μF (low ESR), C_{IN_HIGH} = 1μF (ceramic), R_{IN_HIGH} = 3.9kΩ, R_{OSC} = 10kΩ, T_J = -40°C to +125°C, unless otherwise noted.) (Note 2)

PARAMETER	SYMBOL	CONDITIONS	MIN	TYP	MAX	UNITS
IN_HIGH Startup Voltage	IN_HIGH UVLO	Rising, ON/OFF = IN_HIGH, GATE rising		3.6	4.1	V
		Falling, ON/OFF = IN_HIGH, GATE falling		3.45		
GATE Charge Current	I _{GATE_CH}	V _{IN_HIGH} = V _{ON/OFF} = 14V, V _{GATE} = V+ = 0V	20	45	80	μA
GATE Output Voltage	V _{GATE} - V _{IN_HIGH}	V+ = V _{IN_HIGH} = V _{ON/OFF} = 4.5V, I _{GATE} = 1μA	4.0	5.3	7.5	V
		V+ = V _{IN_HIGH} = V _{ON/OFF} = 14V, I _{GATE} = 1μA		9		
GATE Turn-Off Pulldown Current	I _{GATE_PD}	V _{IN_HIGH} = 14V, V _{ON/OFF} = 0V, V+ = 0V, V _{GATE} = 5V		3.6		mA
STARTUP/V_L REGULATOR						
V _L Undervoltage-Lockout Trip Level	UVLO	V _L falling	3.9	4.1	4.3	V
V _L Undervoltage-Lockout Hysteresis				180		mV
V _L Output Voltage	V _L	I _{SOURCE_} = 0 to 40mA, 5.5V ≤ V+ ≤ 19V	5.0	5.2	5.5	V
V _L LDO Short-Circuit Current	I _{VL_SHORT}	V+ = V _{IN_HIGH} = 5.2V		130		mA
V _L LDO Dropout Voltage	V _{LDO}	I _{SOURCE_} = 40mA, V+ = V _{IN_HIGH} = 4.5V		300	550	mV
BYPASS OUTPUT						
BYPASS Voltage	V _{BYPASS}	I _{BYPASS} = 0μA	1.98	2.00	2.02	V
BYPASS Load Regulation	ΔV _{BYPASS}	0 < I _{BYPASS} < 100μA (sourcing)		2	5	mV
SOFT-START/SOFT-STOP						
Digital Ramp Period Soft-Start/Soft-Stop		Internal 6-bit DAC		2048		fsw Clock Cycles
Soft-Start/Soft-Stop Steps				64		Steps
VOLTAGE-ERROR AMPLIFIER						
FB_ Input Bias Current	I _{FB_}				250	nA
FB_ Input-Voltage Set Point	V _{FB_}	-40°C ≤ T _A ≤ +85°C	0.783	0.8	0.809	V
		-40°C ≤ T _A ≤ +125°C	0.785		0.814	
FB_ to COMP_ Transconductance	g _M		1.4	2.4	3.4	mS
INTERNAL MOSFETS						
On-Resistance High-Side MOSFET Converter 1	R _{ON1}	I _{SWITCH} = 100mA, BST1/VDD1 to V _{SOURCE1} = 5.2V		195		mΩ
		I _{SWITCH} = 100mA, BST1/VDD1 to V _{SOURCE1} = 4.5V		208	355	

Dual, 2.2MHz, Automotive Synchronous Buck Converter with 80V Load-Dump Protection

ELECTRICAL CHARACTERISTICS (continued)

(VDRV = VL, V+ = VL = IN_HIGH = 5.2V or V+ = IN_HIGH = 5.2V to 19V, EN_ = VL, SYNC = GND, IVL = 0mA, PGND = SGND, CBYPASS = 0.22μF (low ESR), CVL = 4.7μF (ceramic), CV+ = 1μF (low ESR), CIN_HIGH = 1μF (ceramic), RIN_HIGH = 3.9kΩ, ROSC = 10kΩ, TJ = -40°C to +125°C, unless otherwise noted.) (Note 2)

PARAMETER	SYMBOL	CONDITIONS	MIN	TYP	MAX	UNITS
On-Resistance High-Side MOSFET Converter 2	RON2	ISWITCH = 100mA, BST2/VDD2 to VSOURCE2 = 5.2V		280		mΩ
		ISWITCH = 100mA, BST2/VDD2 to VSOURCE2 = 4.5V		300	520	
Minimum Converter 1 Output Current	IOUT1	VOUT1 = 5V, V+ = 12V (Note 4)		2		A
Minimum Converter 2 Output Current	IOUT2	VOUT2 = 3.3V, V+ = 12V (Note 4)		1		A
Converter 1/Converter 2 MOSFET DRAIN_ Leakage Current	ILK12	VEN1 = VEN2 = 0V, VDS = 19V, VDRAIN_ = 19V, VSOURCE_ = 0V			20	μA
Internal Weak Low-Side Switch On-Resistance	RONLSSW_	ILSSW = 30mA		22		Ω
INTERNAL SWITCH CURRENT LIMIT						
Internal Switch Current-Limit Converter 1	ICL1	V+ = VIN_HIGH = 5.2V, VL = VDRV = VBST_/VDD_ = 5.2V	2.8	3.45	4.3	A
Internal Switch Current-Limit Converter 2	ICL2	V+ = VIN_HIGH = 5.2V, VL = VDRV = VBST_/VDD_ = 5.2V	1.75	2.10	2.60	A
SWITCHING FREQUENCY						
PWM Maximum Duty Cycle	DMAX	SYNC = SGND, fSW = 1.25MHz	90	92	100	%
Switching Frequency Range	fsw		200		2200	kHz
Switching Frequency	fsw	ROSC = 6.81kΩ, each converter	1.7	1.9	2.1	MHz
Switching Frequency Accuracy		5.6kΩ < ROSC < 10kΩ, 1%		5		%
		10kΩ < ROSC < 62.5kΩ, 1%		7		
SYNC Frequency Range	fSYNC	Each converter switching frequency is half of the SYNC input frequency, FSEL_1 = VL (see the <i>Setting the Switching Frequency</i> section)	400		4400	kHz
SYNC High Threshold	VSYNCH		2			V
SYNC Low Threshold	VSYNCL				0.8	V
SYNC Input Leakage	ISYNC_LEAK				2	μA
SYNC Input Minimum Pulse Width	tSYNCIN			100		ns
Sync to Source 1 Phase Delay	SYNCPHASE	ROSC = 62.5kΩ		90		Degrees

Dual, 2.2MHz, Automotive Synchronous Buck Converter with 80V Load-Dump Protection

MAX5099

ELECTRICAL CHARACTERISTICS (continued)

(VDRV = VL, V+ = VL = IN_HIGH = 5.2V or V+ = IN_HIGH = 5.2V to 19V, EN_ = VL, SYNC = GND, IVL = 0mA, PGND = SGND, CBYPASS = 0.22μF (low ESR), CVL = 4.7μF (ceramic), CV+ = 1μF (low ESR), CIN_HIGH = 1μF (ceramic), RIN_HIGH = 3.9kΩ, ROSC = 10kΩ, TJ = -40°C to +125°C, unless otherwise noted.) (Note 2)

PARAMETER	SYMBOL	CONDITIONS	MIN	TYP	MAX	UNITS
INTERNAL DL_ DRIVERS						
RDS(ON) DL_ Sink	RONDLN	ISINK = 200mA		1		Ω
RDS(ON) DL_ Source	RONDLP	ISOURCE = 200mA		1.8		Ω
Break-Before-Make Time				50		ns
FSEL_1						
FSEL_1 Input High Threshold	VIH		2			V
FSEL_1 Input Low Threshold	VIL				0.8	V
FSEL_1 Input Leakage	IFSEL_1_LEAK				2	μA
ON/OFF						
ON/OFF Input High Threshold	VIH		2			V
ON/OFF Input Low Threshold	VIL				0.8	V
ON/OFF Input Leakage Current	ION/OFF_LEAK	VON/OFF = 5V		0.35	2	μA
EN_ INPUTS						
EN_ Input High Threshold	VIH	EN_ rising	1.9	2.0	2.1	V
EN_ Input Hysteresis	VEN_HYS			0.5		V
EN_ Input Leakage Current	IEN_LEAK		-1		+1	μA
POWER-GOOD OUTPUT (PGOOD1, PGOOD2)						
PGOOD_ Threshold	VTPGOOD_	Falling	90	92.5	95	% VFB_
PGOOD_ Output Voltage	VPGOOD_	ISINK = 3mA			0.4	V
PGOOD_ Output Leakage Current	ILKPGOOD_	V+ = VL = VIN_HIGH = VEN_ = 5.2V, VPGOOD_ = 23V, VFB_ = 1V			2	μA
OUTPUT OVERVOLTAGE PROTECTION						
FB_ OVP Threshold Rising	VOVP_R		107	114	121	% VFB
FB_ OVP Threshold Falling	VOVP_F			112.5		% VFB
THERMAL PROTECTION						
Thermal Shutdown	TSHDN	Rising		+165		°C
Thermal Hysteresis	THYST			20		°C

Note 2: 100% tested at TA = +25°C and TA = +125°C. Specifications at TA = -40°C are guaranteed by design and not production tested.

Note 3: Operating supply range (V+) is guaranteed by VL line regulation test. Connect V+ to IN_HIGH and VL for 5V operation.

Note 4: Output current is limited by the power dissipation of the package; see the *Power Dissipation* section in the *Applications Information* section.

Dual, 2.2MHz, Automotive Synchronous Buck Converter with 80V Load-Dump Protection

Typical Operating Characteristics

(V_+ = V_{IN_HIGH} = 14V, unless otherwise noted. V_+ = V_{IN_HIGH} means that N1 is shorted externally.)

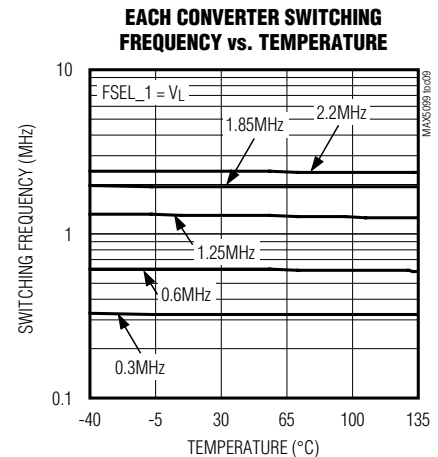
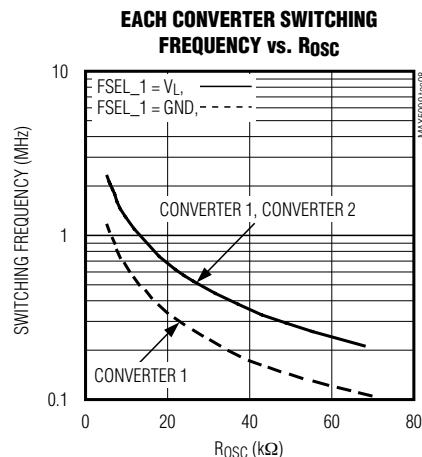
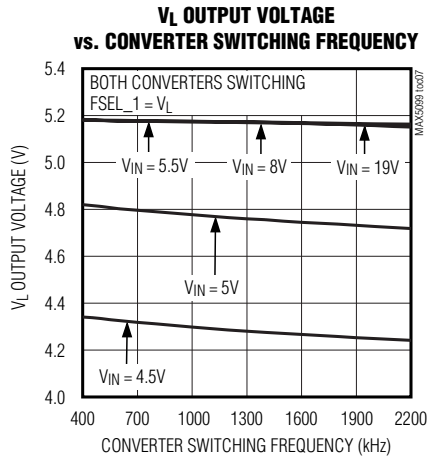
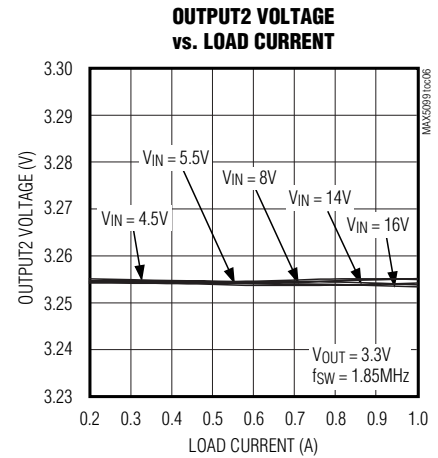
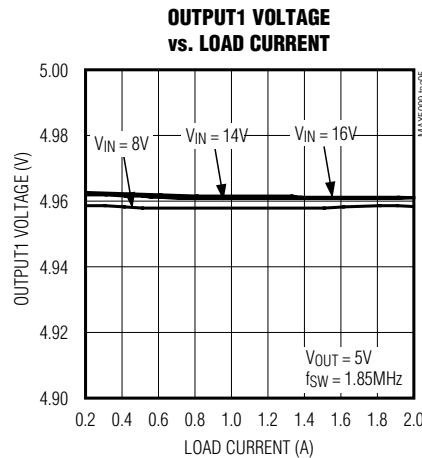
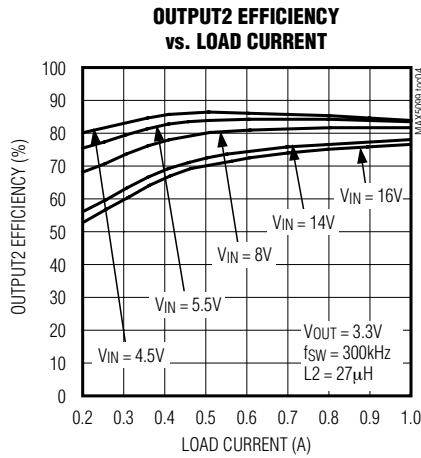
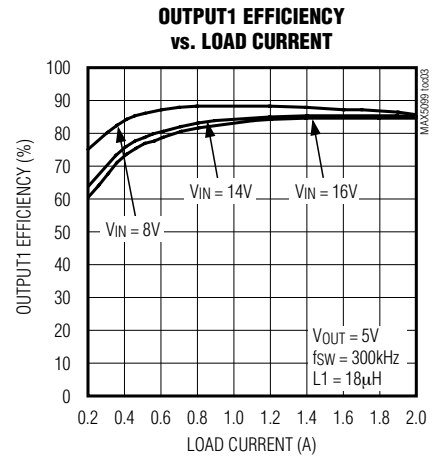
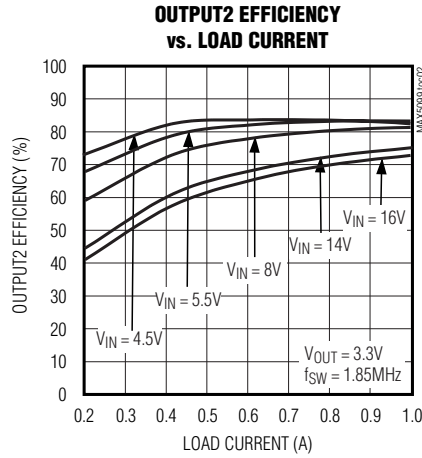
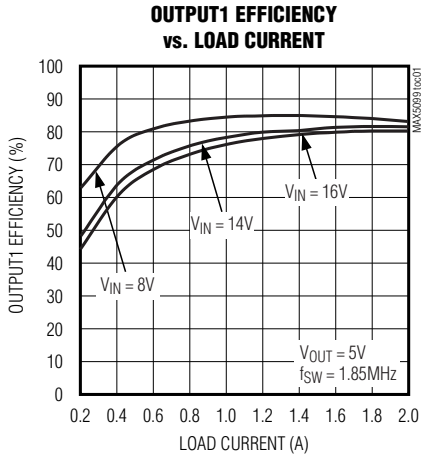

Dual, 2.2MHz, Automotive Synchronous Buck Converter with 80V Load-Dump Protection

MAX5099

Typical Operating Characteristics (continued)

($V_+ = V_{IN_HIGH} = 14V$, unless otherwise noted. $V_+ = V_{IN_HIGH}$ means that N1 is shorted externally.)

**LINE-TRANSIENT RESPONSE
(BUCK CONVERTER)**

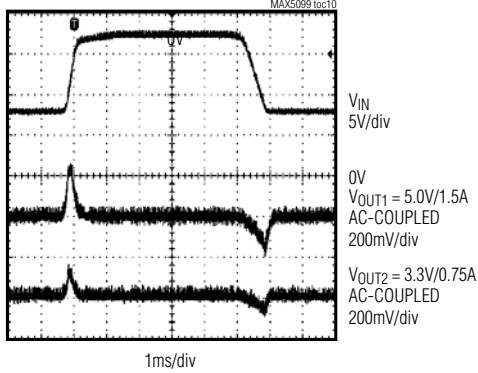

**CONVERTER 1
LOAD-TRANSIENT RESPONSE**

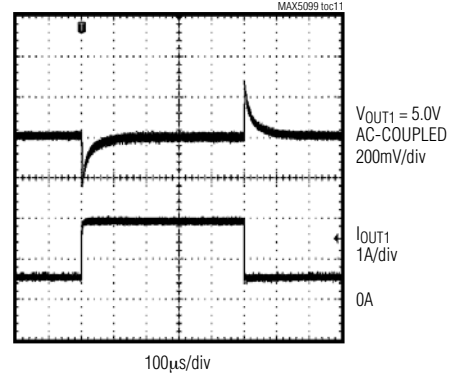

**CONVERTER 2
LOAD-TRANSIENT RESPONSE**

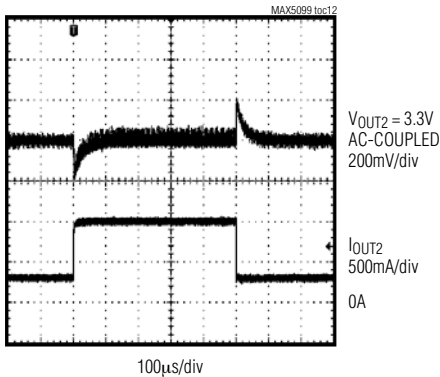

SOFT-START/SOFT-STOP FROM EN1

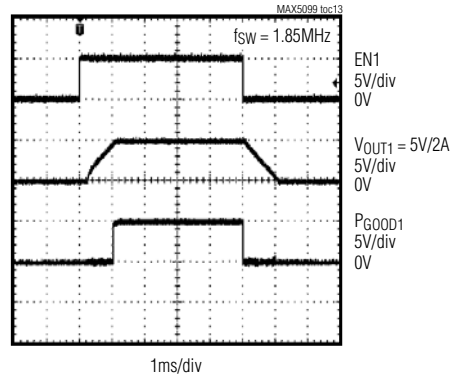

SOFT-START FROM ON/OFF

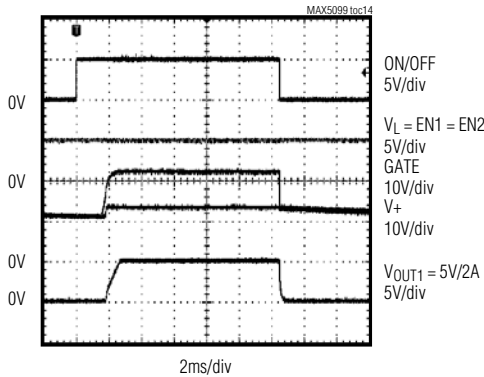

**OUT-OF-PHASE OPERATION
(FSEL_1 = VL)**

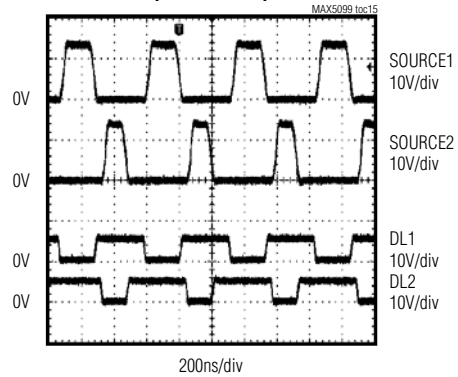

Dual, 2.2MHz, Automotive Synchronous Buck Converter with 80V Load-Dump Protection

Typical Operating Characteristics (continued)

($V_+ = V_{IN_HIGH} = 14V$, unless otherwise noted. $V_+ = V_{IN_HIGH}$ means that N1 is shorted externally.)

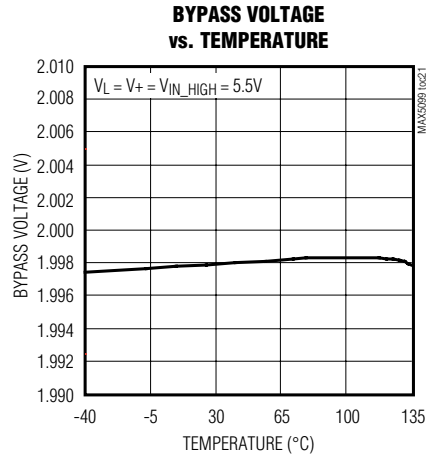
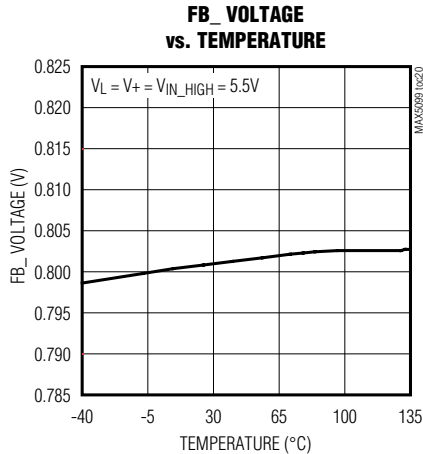
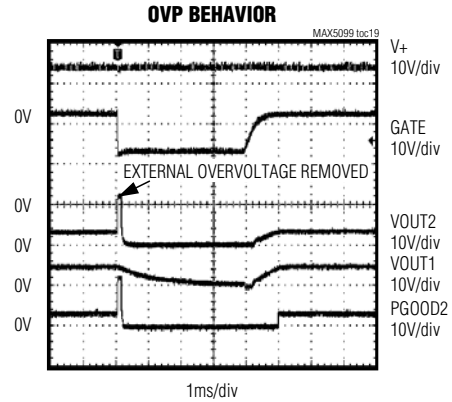
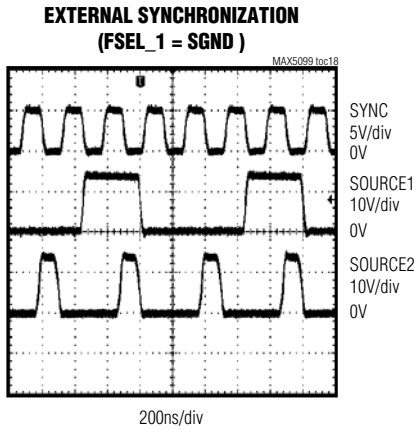
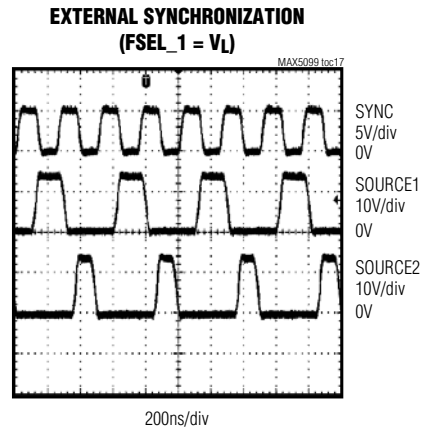
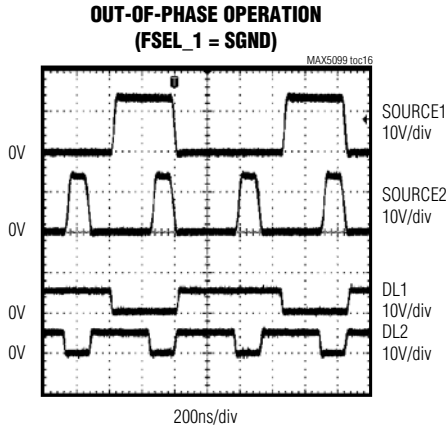

Dual, 2.2MHz, Automotive Synchronous Buck Converter with 80V Load-Dump Protection

MAX5099

Typical Operating Characteristics (continued)

($V_+ = V_{IN_HIGH} = 14V$, unless otherwise noted. $V_+ = V_{IN_HIGH}$ means that N1 is shorted externally.)

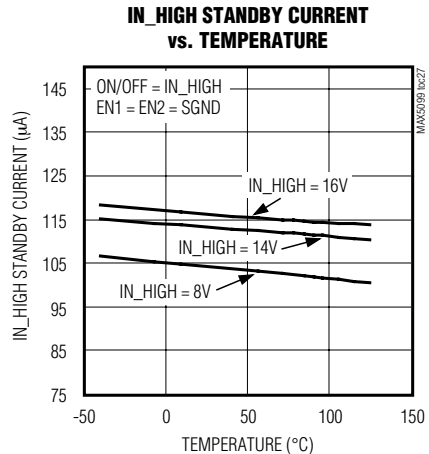
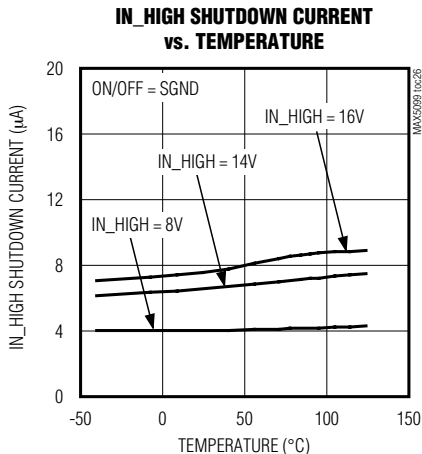
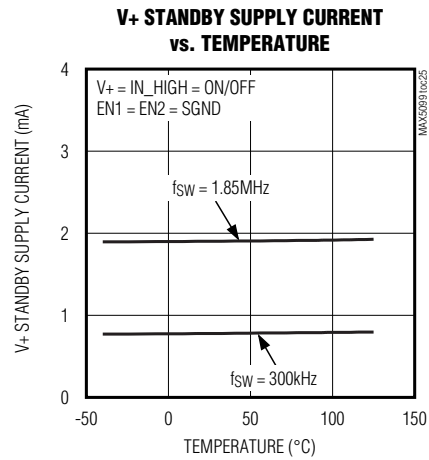
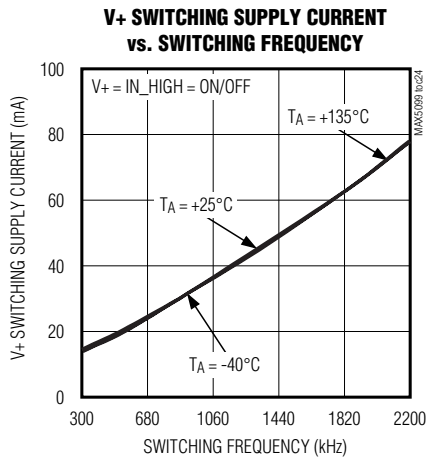
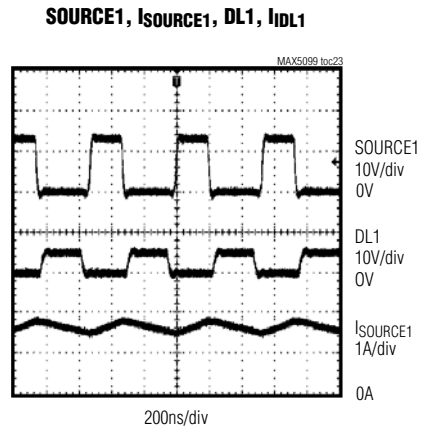
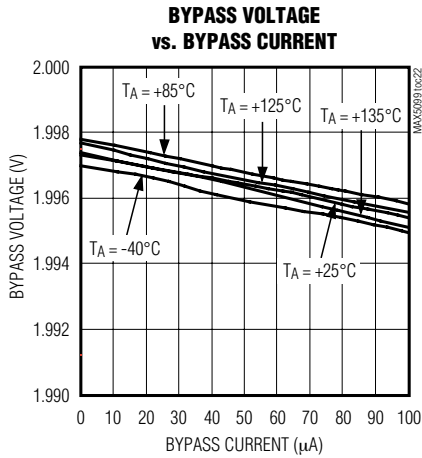

Dual, 2.2MHz, Automotive Synchronous Buck Converter with 80V Load-Dump Protection

Typical Operating Characteristics (continued)

($V_+ = V_{IN_HIGH} = 14V$, unless otherwise noted. $V_+ = V_{IN_HIGH}$ means that N1 is shorted externally.)

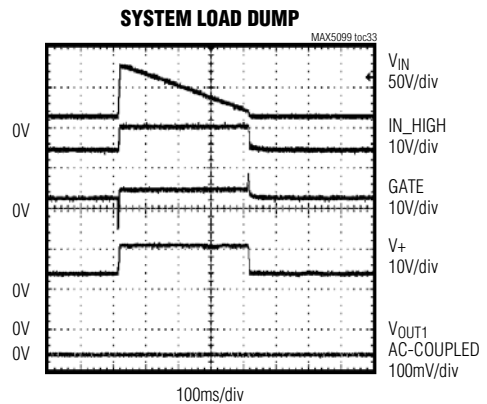
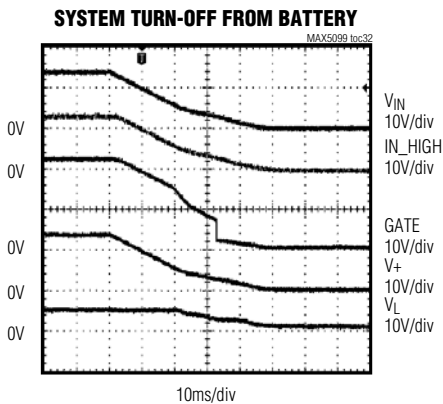
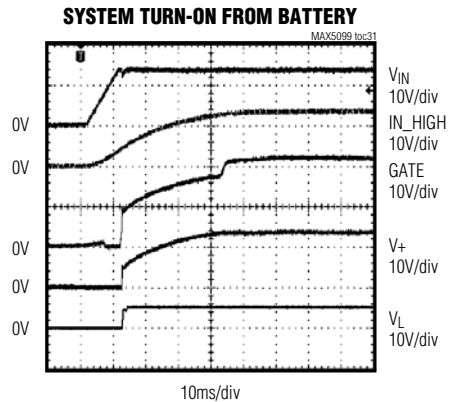
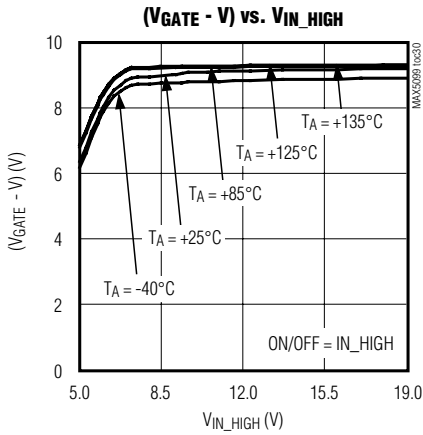
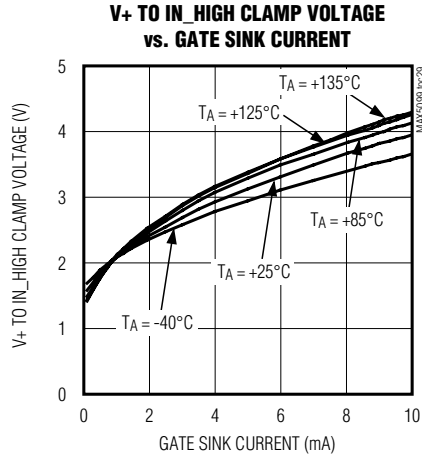
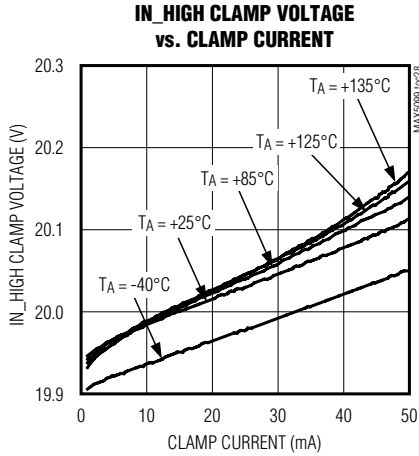

Dual, 2.2MHz, Automotive Synchronous Buck Converter with 80V Load-Dump Protection

Pin Description

MAX5099

PIN	NAME	FUNCTION
1, 32	SOURCE2	Converter 2 Internal MOSFET Source Connection. For buck converter operation, connect SOURCE2 to the switched side of the inductor. For boost operation, connect SOURCE2 to PGND (Figure 5).
2, 3	DRAIN2	Converter 2 Internal MOSFET Drain Connection. For buck converter operation, use the MOSFET as a high-side switch and connect DRAIN2 to the DC-DC converters supply input rail. For boost converter operation, use the MOSFET as a low-side switch and connect DRAIN2 to the inductor and diode junction (Figure 5).
4	PGOOD2	Converter Open-Drain Power-Good Output. PGOOD2 goes low when converter 2's output falls below 92.5% of its set regulation voltage. Use PGOOD2 and EN1 to sequence the converters.
5	EN2	Converter 2 Active-High Enable Input. Connect to V_L for always-on operation.
6	FB2	Converter 2 Feedback Input. Connect FB2 to a resistive divider between converter 2's output and SGND to adjust the output voltage. To set the output voltage below 0.8V, connect FB2 to a resistive voltage-divider from BYPASS to regulator 2's output (Figure 2). See the <i>Setting the Output Voltage</i> section.
7	COMP2	Converter 2 Internal Transconductance Amplifier Output. See the <i>Compensation</i> section.
8	OSC	Oscillator Frequency Set Input. Connect a resistor from OSC to SGND (R_{OSC}) to set the switching frequency (see the <i>Setting the Switching Frequency</i> section). Set R_{OSC} for an oscillator frequency equal to the SYNC input frequency when using external synchronization. R_{OSC} is still required when an external clock is connected to the SYNC input. See the <i>Synchronization (SYNC)</i> section.
9	SYNC	External Clock Synchronization Input. Connect SYNC to a 400kHz to 4400kHz clock to synchronize the switching frequency with the system clock. Each converter frequency is 1/2 of the frequency applied to SYNC ($FSEL_1 = V_L$). For $FSEL_1 = SGND$, the switching frequency of converter 1 becomes 1/4 of the SYNC frequency. Connect SYNC to SGND when not used.
10	GATE	Gate Drive Output. Connect to the gate of the external n-channel load-dump protection MOSFET. $GATE = IN_HIGH + 9V$ (typ) with $IN_HIGH = 12V$. GATE pulls to IN_HIGH by an internal n-channel MOSFET when $V+$ raises 2V above IN_HIGH . Leave GATE unconnected if the load-dump protection is not used (MOSFET not installed).
11	ON/OFF	n-Channel Switch Enable Input. Drive ON/OFF high for normal operation. Drive ON/OFF low to turn off the external n-channel load-dump protection MOSFET and reduce the supply current to 7 μ A (typ). When ON/OFF is driven low, both DC-DC converters are disabled and the PGOOD_ outputs are driven low. Connect to $V+$ if the external load-dump protection is not used (MOSFET not installed).
12	IN_HIGH	Startup Input. IN_HIGH is protected by internally clamping to 21V (max). Connect a resistor (4k Ω max) from IN_HIGH to the drain of the protection switch. Bypass IN_HIGH with a 4.7 μ F electrolytic or 1 μ F minimum ceramic capacitor. Connect to $V+$ if the external load-dump protection is not used (MOSFET not installed).
13	$V+$	Input Supply Voltage. $V+$ can range from 5.2V to 19V. Connect $V+$, IN_HIGH , and V_L together for 4.5V to 5.5V input operation. Bypass $V+$ to SGND with a 1 μ F minimum ceramic capacitor.
14	V_L	Internal Regulator Output. The V_L regulator is used to supply the drive current at input VDRV. When driving VDRV, use an RC lowpass filter to decouple switching noise from VDRV to the V_L regulator (see the <i>Typical Application Circuit</i>). Bypass V_L to SGND with a 4.7 μ F minimum ceramic capacitor.

Dual, 2.2MHz, Automotive Synchronous Buck Converter with 80V Load-Dump Protection

Pin Description (continued)

PIN	NAME	FUNCTION
15	SGND	Signal Ground. Connect SGND to exposed pad and to the board signal ground plane. Connect the board signal ground and power ground planes together at a single point.
16	BYPASS	Reference Output Bypass Connection. Bypass to SGND with a 0.22 μ F or greater ceramic capacitor.
17	FSEL_1	Converter 1 Frequency Select Input. Connect FSEL_1 to V _L for normal operation. Connect FSEL_1 to SGND to reduce converter 1's switching frequency to 1/2 of converter 2's switching frequency (converter 1 switching frequency is 1/4 the SYNC frequency). Do not leave FSEL_1 unconnected.
18	COMP1	Converter 1 Internal Transconductance Amplifier Output. See the <i>Compensation</i> section.
19	FB1	Converter 1 Feedback Input. Connect FB1 to a resistive divider between converter 1's output and SGND to adjust the output voltage. To set the output voltage below 0.8V, connect FB1 to a resistive voltage-divider from BYPASS to regulator 1's output (Figure 2). See the <i>Setting the Output Voltage</i> section.
20	EN1	Converter 1 Active-High Enable Input. Connect to V _L for an always-on operation.
21	PGOOD1	Converter 1 Power-Good Output. Open-drain output goes low when converter 1's output falls below 92.5% of its set regulation voltage. Use PGOOD1 and EN2 to sequence the converters (converter 1 starts first).
22, 23	DRAIN1	Converter 1 Internal MOSFET Drain Connection. For buck converter operation, use the MOSFET as a high-side switch and connect DRAIN1 to the DC-DC converters supply input rail. For boost converter operation, use the MOSFET as a low-side switch and connect DRAIN1 to the inductor and diode junction (Figure 5).
24, 25	SOURCE1	Converter 1 Internal MOSFET Source Connection. For buck operation, connect SOURCE1 to the switched side of the inductor. For boost operation, connect SOURCE1 to PGND (Figure 5).
26	BST1/VDD1	Converter 1 Bootstrap Flying-Capacitor Connection. For buck converter operation, connect BST1/VDD1 to a 0.1 μ F ceramic capacitor and diode according to the <i>Typical Application Circuit</i> . For boost converter operation, driver bypass capacitor connection. Connect to VDRV and bypass with a 0.1 μ F ceramic capacitor to PGND (Figure 5).
27	VDRV	Low-Side Driver Supply Input. Connect VDRV to V _L through an RC filter to bypass switching noise to the internal V _L regulator. For buck converter operation, connect anode terminals of external bootstrap diodes to VDRV. For boost converter operation, connect VDRV to BST1/VDD1 and BST2/VDD2. Bypass with a minimum 2.2 μ F ceramic capacitor to PGND (see the <i>Typical Application Circuit</i>). Do not connect to an external supply.
28	DL1	Converter 1 Low-Side Synchronous-Rectifier Gate Driver Output
29	PGND	Power Ground. Connect to the board power ground plane.
30	DL2	Converter 2 Low-Side Synchronous-Rectifier Gate Driver Output
31	BST2/VDD2	Converter 2 Bootstrap Flying-Capacitor Connection. For buck converter operation, connect BST2/VDD2 to a 0.1 μ F ceramic capacitor and diode according to the <i>Typical Application Circuit</i> . For boost converter operation, driver bypass capacitor connection. Connect to VDRV and bypass with a 0.1 μ F ceramic capacitor from BST2/VDD2 to PGND (Figure 5).
—	EP	Exposed Pad. Connect EP to SGND. For enhanced thermal dissipation, connect EP to a copper area as large as possible. Do not use EP as the sole ground connection.

Dual, 2.2MHz, Automotive Synchronous Buck Converter with 80V Load-Dump Protection

Functional Diagram

MAX5099

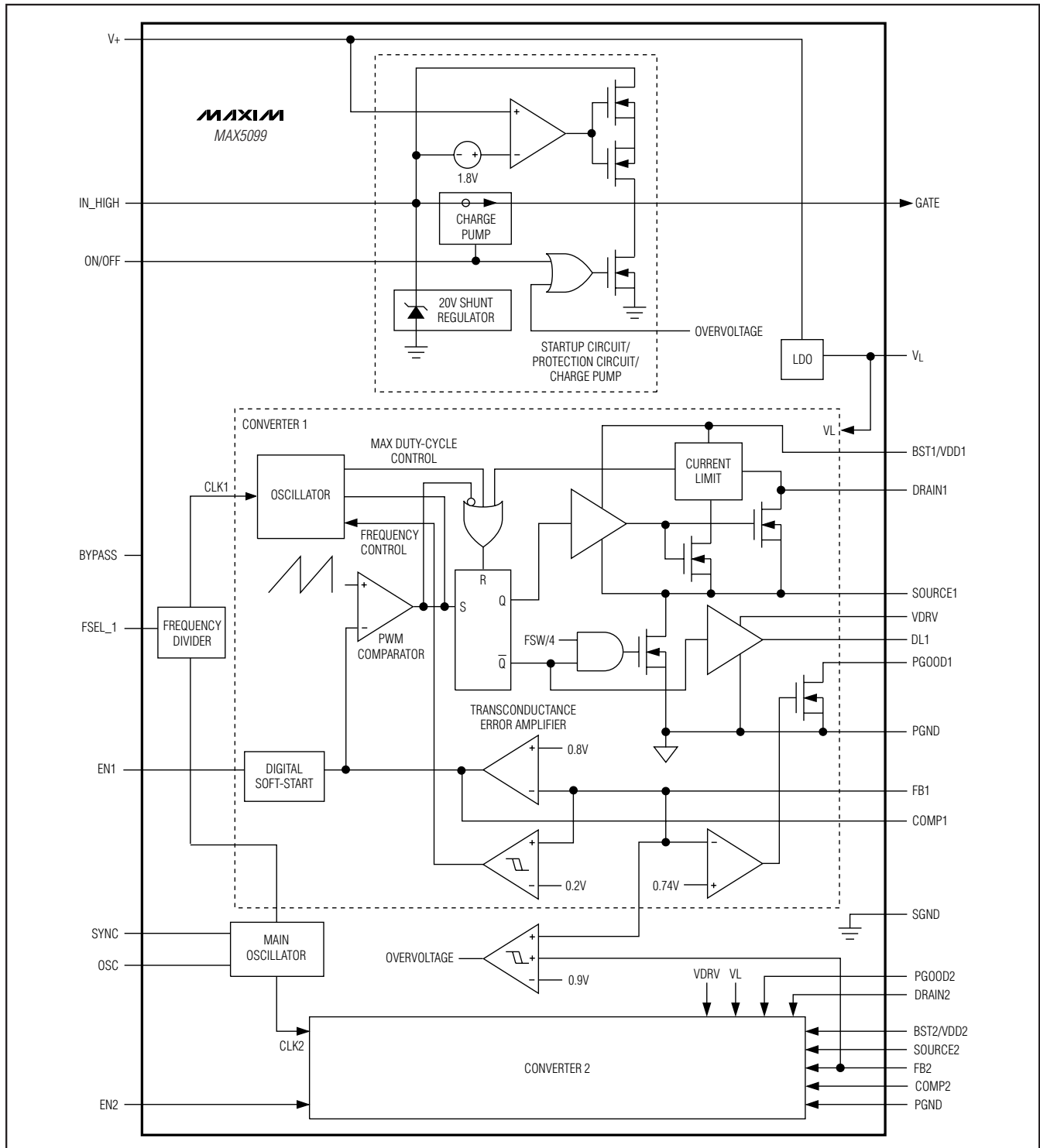

Dual, 2.2MHz, Automotive Synchronous Buck Converter with 80V Load-Dump Protection

Detailed Description

PWM Controller

The MAX5099 dual DC-DC converters use a pulse-width-modulation (PWM) voltage-mode control scheme. On each converter the device includes one integrated n-channel MOSFET switch and requires an external low-forward-drop Schottky diode for output rectification. The controller generates the clock signal by dividing down the internal oscillator (f_{OSC}) or the SYNC input when driven by an external clock; therefore, each controller's switching frequency equals half the oscillator frequency ($f_{SW} = f_{OSC}/2$) or half of the SYNC input frequency ($f_{SW} = f_{SYNC}/2$). An internal transconductance error amplifier produces an integrated error voltage at COMP_, providing high DC accuracy. The voltage at COMP_ sets the duty cycle using a PWM comparator and a ramp generator. At each rising edge of the clock, converter 1's MOSFET switch turns on and remains on until either the appropriate or maximum duty cycle is reached, or the maximum current limit for the switch is reached. Converter 2 operates 180° out-of-phase, so its MOSFET switch turns on at each falling edge of the clock.

In the case of buck operation (see the *Typical Application Circuit*), the internal MOSFET is used in high-side configuration. During each MOSFET's on-time, the associated inductor current ramps up. During the second half of the switching cycle, the high-side MOSFET turns off and forward biases the Schottky rectifier. During this time, the SOURCE_ voltage is clamped to a diode drop (V_D) below ground. A low-forward-voltage-drop (0.4V) Schottky diode must be used to ensure the SOURCE_ voltage does not go below -0.6V absolute max. The inductor releases the stored energy as its current ramps down, and provides current to the output. The bootstrap capacitor is also recharged when the SOURCE_ voltage goes low during the high-side MOSFET off-time. The maximum duty-cycle limits ensure proper bootstrap charging at startup or low input voltages. The circuit goes in discontinuous conduction mode operation at light load, when the inductor current completely discharges before the next cycle commences. Under overload conditions, when the inductor current exceeds the peak current limit of the respective switch, the high-side MOSFET turns off quickly and waits until the next clock cycle.

Synchronous-Rectifier Output

The MAX5099 is intended mostly for synchronous buck operation with an external synchronous-rectifier MOSFET. During the internal high-side MOSFET on-time, the inductor current ramps up. When the high-side MOSFET turns off, the inductor reverses polarity and forward biases the Schottky rectifier in parallel with the low-side external

synchronous MOSFET. The SOURCE_ voltage is clamped to 0.5V below ground until the adaptive break-before-make time (t_{BBM}) of 25ns is over. After t_{BBM} , the synchronous-rectifier MOSFET turns on, thus bypassing the Schottky rectifier and reducing the conduction loss during the inductor freewheeling time. The synchronous-rectifier MOSFET keeps the circuit in continuous conduction mode operation even at light load because the inductor current is allowed to go negative.

The MAX5099, with the synchronous-rectifier driver output (DL_), has an adaptive break-before-make circuit to avoid cross-conduction between the internal power MOSFET and the external synchronous-rectifier MOSFET. When the synchronous-rectifier MOSFET is turning off, the internal high-side power MOSFET is kept off until V_{DL} falls below 0.97V. Similarly, DL_ does not go high until the internal power MOSFET gate voltage falls below 1.24V.

Load-Dump Protection

Most automotive applications are powered by a multi-cell, 12V lead-acid battery with a voltage from 9V to 16V (depending on load current, charging status, temperature, battery age, etc.). The battery voltage is distributed throughout the automobile and is locally regulated down to voltages required by the different system modules. Load dump occurs when the alternator is charging the battery and the battery becomes disconnected. Power in the alternator inductance flows into the distributed power system and elevates the voltage seen at each module. The voltage spikes have rise times typically greater than 5ms and decays within several hundred milliseconds but can extend out to 1s or more depending on the characteristics of the charging system. These transients are capable of destroying sensitive electronic equipment on the first fault event.

During load dump, the MAX5099 provides the ability to clamp the input-voltage rail of the internal DC-DC converters to a safe level, while preventing power discontinuity at the DC-DC converters' outputs.

The load-dump protection circuit utilizes an internal charge pump to drive the gate of an external n-channel MOSFET. This series-protection MOSFET absorbs the load-dump overvoltage transient and operates in saturation over the normal battery range to minimize power dissipation. During load dump, the gate voltage of the protection MOSFET is regulated to prevent the source terminal from exceeding 19V.

The DC-DC converters are powered from the source terminal of the load-dump protection MOSFET, so that their input voltage is limited during load dump and can operate normally.

Dual, 2.2MHz, Automotive Synchronous Buck Converter with 80V Load-Dump Protection

ON/OFF

The MAX5099 provide an input (ON/OFF) to turn on and off the external load-dump protection MOSFET. Drive ON/OFF high for normal operation. Drive ON/OFF low to turn off the external n-channel load-dump protection MOSFET and reduce the supply current to 7 μ A (typ). When ON/OFF is driven low, both converters are also turned off, and the PGOOD_ outputs are driven, low. V+ will be self-discharged through the converters' output currents and the IC supply current.

Internal Oscillator/ Out-of-Phase Operation

The internal oscillator generates the 180° out-of-phase clock signal required by each regulator. The switching frequency of each converter (f_{sw}) is programmable from 200kHz to 2.2MHz using a single 1% resistor at ROSC. See the *Setting the Switching Frequency* section.

With dual-synchronized out-of-phase operation, the MAX5099's internal MOSFETs turn on 180° out-of-phase. The instantaneous input current peaks of both regulators do not overlap, resulting in reduced RMS ripple current and input-voltage ripple. This reduces the required input capacitor ripple current rating, allows for fewer or less expensive capacitors, and reduces shielding requirements for EMI.

Synchronization (SYNC)

The main oscillator can be synchronized to the system clock by applying an external clock (f_{SYNC}) at SYNC. The f_{SYNC} frequency must be twice the required operating frequency of an individual converter. Use a TTL logic signal for the external clock with at least a 100ns pulse width. ROSC is still required when using external synchronization. Program the internal oscillator frequency to have f_{sw} = 1/2 f_{SYNC}. The device is properly synchronized if the SYNC frequency f_{SYNC} varies within the range $\pm 20\%$.

Short SYNC to SGND if unused.

Input Voltage (V+) Internal Linear Regulator (VL)

All internal control circuitry operates from an internally regulated nominal voltage of 5.2V (V_L). At higher input voltages (V+) of 5.2V to 19V, V_L is regulated to 5.2V. At

5.2V or below, the internal linear regulator operates in dropout mode, where V_L follows V+. Depending on the load on V_L, the dropout voltage can be high enough to reduce V_L below the undervoltage-lockout (UVLO) threshold. Do not use V_L to power external circuitry.

For input voltages less than 5.5V, connect V+ and V_L together. The load on V_L is proportional to the switching frequency of converter 1 and converter 2. See the V_L Output Voltage vs. Converter Switching Frequency graph in the *Typical Operating Characteristics*. For input voltage ranges higher than 5.5V, disconnect V_L from V+.

Bypass V+ to SGND with a 1 μ F or greater ceramic capacitor placed close to the MAX5099. Bypass V_L with a low-ESR 4.7 μ F ceramic capacitor to SGND.

Undervoltage Lockout/ Soft-Start/Soft-Stop

The MAX5099 includes an undervoltage lockout with hysteresis and a power-on-reset circuit for converter turn-on and monotonic rise of the output voltage. The falling UVLO threshold is internally set to 4.1V (typ) with 180mV hysteresis. Hysteresis at UVLO eliminates "chattering" during startup. When V_L drops below UVLO, the internal MOSFET switches are turned off.

The MAX5099 digital soft-start reduces input inrush currents and glitches at the input during turn-on. When UVLO is cleared and EN_ is high, digital soft-start slowly ramps up the internal reference voltage in 64 steps. The total soft-start period is 4096 internal oscillator switching cycles.

Driving EN_ low initiates digital soft-stop that slowly ramps down the internal reference voltage in 64 steps. The total soft-stop period is equal to the soft-start period.

To calculate the soft-start/soft-stop period, use the following equation:

$$t_{ss}(\text{ms}) = \frac{4096}{f_{OSC}(\text{kHz})}$$

where f_{OSC} is the internal oscillator and f_{OSC} is twice each converter's switching frequency (FSEL_1 = V_L).

Dual, 2.2MHz, Automotive Synchronous Buck Converter with 80V Load-Dump Protection

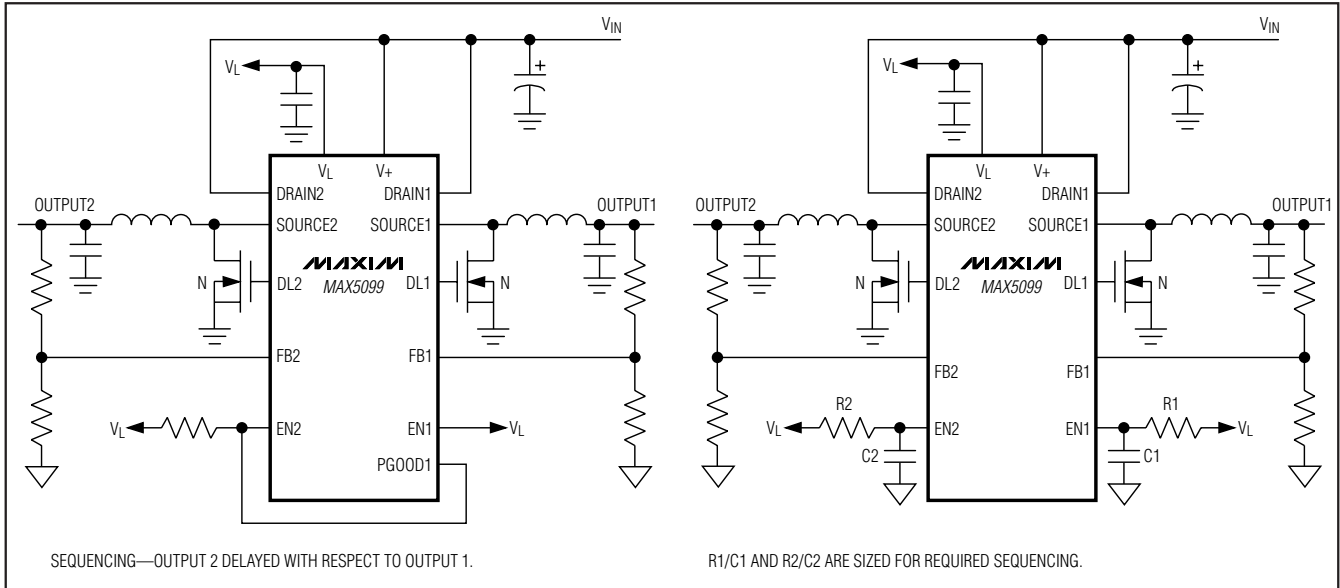

Figure 1. Power-Supply Sequencing Configurations

Enable (EN1, EN2)

The MAX5099 dual converter provides separate enable inputs, EN1 and EN2, to individually control or sequence the output voltages. These active-high enable inputs are TTL compatible. Driving EN_n high initiates soft-start of the converter, and PGOOD_n goes logic-high when the converter output voltage reaches the VTPGOOD_n threshold. Driving EN_n low initiates a soft-stop of the converter. Use EN1, EN2, and PGOOD1 for sequencing (see Figure 1). Connect PGOOD1 to EN2 to make sure converter 1's output is within regulation before converter 2 starts. Add an RC network from V_L to EN1 and EN2 to delay the individual converter. Sequencing reduces input inrush current and possible chattering. Connect EN_n to V_L for always-on operation.

PGOOD_n

Converter 1 and converter 2 include power-good flags, PGOOD1 and PGOOD2, respectively. Since PGOOD_n is an open-drain output and can sink 3mA while providing the TTL logic-low signal, pull PGOOD_n to a logic voltage to provide a logic-level output. PGOOD1 goes low when converter 1's feedback (FB₁) drops to 92.5% (VTPGOOD₁) of its nominal set point. The same is true for converter 2. Connect PGOOD_n to SGND or leave unconnected, if not used.

Current Limit

The internal high-side MOSFET switch current of each converter is monitored during its on-time. When the peak switch current crosses the current-limit threshold

of 3.45A (typ) and 2.1A (typ) for converter 1 and converter 2, respectively, the on-cycle is terminated immediately and the inductor is allowed to discharge. The MOSFET switch is turned on at the next clock pulse initiating a new clock cycle.

In deep overload or short-circuit conditions when V_{FB} drops below 0.2V, the switching frequency is reduced to $1/4 \times f_{sw}$ to provide sufficient time for the inductor to discharge. During overload conditions, if the voltage across the inductor is not high enough to allow for the inductor current to properly discharge, current runaway may occur. Current runaway can destroy the device in spite of internal thermal-overload protection. Reducing the switching frequency during overload conditions prevents current runaway.

Output Overvoltage Protection

The MAX5099 outputs are protected from output voltage overshoots due to input transients and shorting the output to a high voltage. When the output voltage rises over the overvoltage threshold, 114% (typ) nominal FB_n, the overvoltage condition is triggered. When the overvoltage condition is triggered on either channel, both converters are immediately turned off, 20Ω pulldown switches from SOURCE_n to PGND are turned on to help the output-voltage discharge, and the gate of the load-dump protection external MOSFET is pulled low. The device restarts as soon as both converter outputs discharge, bringing both FB_n input voltages below 12.5% of their nominal set points.

Dual, 2.2MHz, Automotive Synchronous Buck Converter with 80V Load-Dump Protection

Thermal-Overload Protection

During continuous short circuit or overload at the output, the power dissipation in the IC can exceed its limit. The MAX5099 provides thermal shutdown protection with temperature hysteresis. Internal thermal shutdown is provided to avoid irreversible damage to the device. When the die temperature exceeds +165°C (typ), an on-chip thermal sensor shuts down the device, forcing the internal switches to turn off, allowing the IC to cool. The thermal sensor turns the part on again with soft-start after the junction temperature cools by +20°C. During thermal shutdown, both regulators shut down, PGOOD₋ goes low, and soft-start resets. The internal 20V zener clamp from IN_{-HIGH} to SGND is not turned off during thermal shutdown because this clamping action must always be active.

Applications Information

Setting the Switching Frequency

The controller generates the clock signal by dividing down the internal oscillator f_{OSC} or the SYNC input signal when driven by an external oscillator. The switching frequency equals half the internal oscillator frequency ($f_{SW} = f_{OSC}/2$). The internal oscillator frequency is set by a resistor (R_{OSC}) connected from OSC to SGND. To find R_{OSC} for each converter switching frequency f_{SW} , use the formulas:

$$R_{OSC}(k\Omega) = \frac{10.721}{f_{SW}(\text{MHz})^{0.920}} (f_{SW} \geq 1.25\text{MHz})$$

$$R_{OSC}(k\Omega) = \frac{12.184}{f_{SW}(\text{MHz})^{0.973}} (f_{SW} < 1.25\text{MHz})$$

A rising clock edge on SYNC is interpreted as a synchronization input. If the SYNC signal is lost, the internal oscillator takes control of the switching rate, returning the switching frequency to that set by R_{OSC} . When an external synchronization signal is used, R_{OSC} must be selected such that $f_{SW} = 1/2 f_{SYNC}$.

Buck Converter

Effective Input Voltage Range

Although the MAX5099 converter operates from input supplies ranging from 5.2V to 19V, the input voltage range can be effectively limited by the MAX5099 duty-cycle limitations for a given output voltage. The maximum

input voltage is limited by the minimum on-time ($t_{ON(MIN)}$):

$$V_{IN(MAX)} \leq \frac{V_{OUT}}{t_{ON(MIN)} \times f_{SW}}$$

where $t_{ON(MIN)}$ is 100ns. The minimum input voltage is limited by the maximum duty cycle ($D_{MAX} = 0.92$):

$$V_{IN(MIN)} = \left[\frac{V_{OUT} + V_{DROP1}}{D_{MAX}} \right] + V_{DROP2} - V_{DROP1}$$

where V_{DROP1} is the total parasitic voltage drops in the inductor discharge path, which includes the forward voltage drop (V_{DS}) of the low-side n-channel MOSFET, the series resistance of the inductor, and the PCB resistance. V_{DROP2} is the total resistance in the charging path that includes the on-resistance of the high-side switch, the series resistance of the inductor, and the PCB resistance.

Setting the Output Voltage

For 0.8V or greater output voltages, connect a voltage-divider from OUT₋ to FB₋ to SGND (Figure 2). Select R_B (FB₋ to SGND resistor) to between 1kΩ and 20kΩ. Calculate R_A (OUT₋ to FB₋ resistor) with the following equation:

$$R_A = R_B \left[\left(\frac{V_{OUT_}}{V_{FB_}} \right) - 1 \right]$$

where $V_{FB_} = 0.8V$ (see the *Electrical Characteristics* table).

For output voltages below 0.8V, set the MAX5099 output voltage by connecting a voltage-divider from OUT₋ to FB₋ to BYPASS (Figure 2). Select R_C (FB₋ to BYPASS resistor) higher than a 50kΩ range. Calculate R_A with the following equation:

$$R_A = R_C \left[\frac{V_{FB_} - V_{OUT_}}{V_{BYPASS} - V_{FB_}} \right]$$

where $V_{FB_} = 0.8V$, $V_{BYPASS} = 2V$ (see the *Electrical Characteristics* table), and $V_{OUT_}$ can range from 0V to $V_{FB_}$.

Dual, 2.2MHz, Automotive Synchronous Buck Converter with 80V Load-Dump Protection

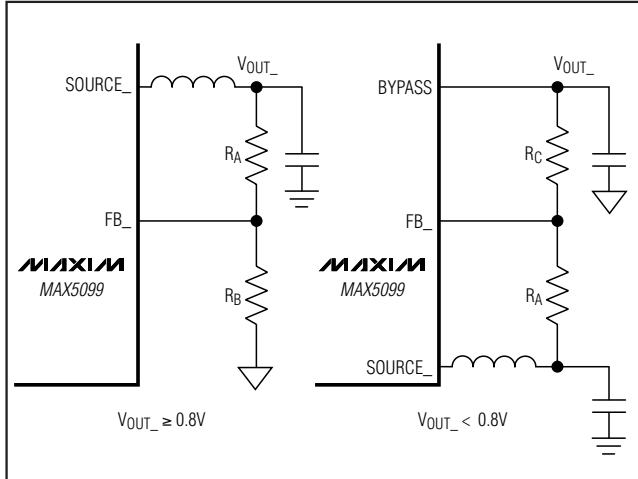

Figure 2. Adjustable Output Voltage

Inductor Selection

Three key inductor parameters must be specified for operation with the MAX5099: inductance value (L), peak inductor current (I_L), and inductor saturation current (I_{SAT}). The minimum required inductance is a function of operating frequency, input-to-output voltage differential, and the peak-to-peak inductor current (ΔI_L). A good compromise is to choose ΔI_L equal to 30% of the full load current. To calculate the inductance, use the following equation:

$$L = \frac{V_{OUT}(V_{IN} - V_{OUT})}{V_{IN} \times f_{SW} \times \Delta I_L}$$

where V_{IN} and V_{OUT} are typical values (so that efficiency is optimum for typical conditions). The switching frequency is set by R_{OSC} (see the *Setting the Switching Frequency* section). The peak-to-peak inductor current, which reflects the peak-to-peak output ripple, is worse at the maximum input voltage. See the *Output Capacitor* section to verify that the worst-case output ripple is acceptable. The inductor saturation current is also important to avoid runaway current during output overload and continuous short circuit. Select the I_{SAT} to be higher than the maximum peak current limits of 4.3A and 2.6A for converter 1 and converter 2.

Input Capacitor

The discontinuous input current waveform of the buck converter causes large ripple currents at the input. The switching frequency, peak inductor current, and allowable peak-to-peak voltage ripple dictate the input

capacitance requirement. Note that the two converters of the MAX5099 run 180° out-of-phase, thereby effectively doubling the switching frequency at the input.

The input ripple waveform would be unsymmetrical due to the difference in load current and duty cycle between converter 1 and converter 2. The worst-case mismatch is when one converter is at full load while the other is at no load or in shutdown. The input ripple is comprised of ΔV_Q (caused by the capacitor discharge) and ΔV_{ESR} (caused by the ESR of the capacitor). Use ceramic capacitors with high ripple-current capability at the input connected between $DRAIN_+$ and $PGND$. Assume the contribution from the ESR and capacitor discharge equal to 50%. Calculate the input capacitance and ESR required for a specified ripple using the following equations:

$$ESR_{IN} = \frac{\Delta V_{ESR}}{I_{OUT} + \frac{\Delta I_L}{2}}$$

where

$$\Delta I_L = \frac{(V_{IN} - V_{OUT}) \times V_{OUT}}{V_{IN} \times f_{SW} \times L}$$

and

$$C_{IN} = \frac{I_{OUT} \times D(1-D)}{\Delta V_Q \times f_{SW}}$$

where

$$D = \frac{V_{OUT}}{V_{IN}}$$

where I_{OUT} is the maximum output current from either converter 1 or converter 2, and D is the duty cycle for that converter. f_{SW} is the frequency of each individual converter. For example, at $V_{IN} = 12V$, $V_{OUT} = 3.3V$ at $I_{OUT} = 2A$, and with $L = 3.3\mu H$, the ESR and input capacitance are calculated for a peak-to-peak input ripple of 100mV or less, yielding an ESR and capacitance value of 20mΩ and 6.8μF for 1.25MHz frequency. At low input voltages, also add one electrolytic bulk capacitor of at least 100μF on the converters' input voltage rail. This capacitor acts as an energy reservoir to avoid possible undershoot below the undervoltage-lockout threshold during power-on and transient loading.

Dual, 2.2MHz, Automotive Synchronous Buck Converter with 80V Load-Dump Protection

Output Capacitor

The allowable output ripple voltage and the maximum deviation of the output voltage during step load currents determine the output capacitance and its ESR. The output ripple is comprised of ΔV_Q (caused by the capacitor discharge) and ΔV_{ESR} (caused by the ESR of the capacitor). Use low-ESR ceramic or aluminum electrolytic capacitors at the output. For aluminum electrolytic capacitors, the entire output ripple is contributed by ΔV_{ESR} . Use the ESR_{OUT} equation to calculate the ESR requirements and choose the capacitor accordingly. If using ceramic capacitors, assume the contribution to the output ripple voltage from the ESR and the capacitor discharge are equal. Calculate the output capacitance and ESR required for a specified ripple using the following equations:

$$ESR_{OUT} = \frac{\Delta V_{ESR}}{\Delta I_L}$$

$$C_{OUT} = \frac{\Delta I_L}{8 \times \Delta V_Q \times f_{SW}}$$

where

$$\Delta V_{O_RIPPLE} \approx \Delta V_{ESR} + \Delta V_Q$$

ΔI_L is the peak-to-peak inductor current as calculated above and f_{SW} is the individual converter's switching frequency.

The allowable deviation of the output voltage during fast transient loads also determines the output capacitance and its ESR. The output capacitor supplies the step load current until the controller responds with a greater duty cycle. The response time ($t_{RESPONSE}$) depends on the closed-loop bandwidth of the converter. The high switching frequency of the MAX5099 allows for higher closed-loop bandwidth, reducing $t_{RESPONSE}$ and the output capacitance requirement. The resistive drop across the output capacitor ESR and the capacitor discharge causes a voltage droop during a step load. Use a combination of low-ESR tantalum or polymer and ceramic capacitors for better transient load and ripple/noise performance. Keep the maximum output-voltage deviation within the tolerable limits of the electronics being powered. When using a ceramic capacitor, assume 80% and 20% contribution from the output capacitance discharge and the ESR drop, respectively. Use the following equations to calculate the required ESR and capacitance value:

$$ESR_{OUT} = \frac{\Delta V_{ESR}}{I_{STEP}}$$

$$C_{OUT} = \frac{I_{STEP} \times t_{RESPONSE}}{\Delta V_Q}$$

where I_{STEP} is the load step and $t_{RESPONSE}$ is the response time of the controller. Controller response time depends on the control-loop bandwidth.

Boost Converter

The MAX5099 can be configured for step-up conversion since the internal MOSFET can be used as a low-side switch. Use the following equations to calculate the values for the inductor (L_{MIN}), input capacitor (C_{IN}), and output capacitor (C_{OUT}) when using the converter in boost operation.

Inductor

Choose the minimum inductor value so the converter remains in continuous mode operation at minimum output current (I_{OMIN}).

$$L_{MIN} = \frac{V_{IN}^2 \times D}{2 \times f_{SW} \times V_O \times I_{OMIN}}$$

where

$$D = \frac{V_O + V_D - V_{IN}}{V_O + V_D - V_{DS}}$$

V_D is the forward voltage drop of the external Schottky diode, D is the duty cycle, and V_{DS} is the voltage drop across the internal MOSFET switch. Select the inductor with low DC resistance and with a saturation current (I_{SAT}) rating higher than the peak switch current limit of 4.3A (I_{CL1}) and 2.6A (I_{CL2}) of converter 1 and converter 2, respectively.

Input Capacitor

The input current for the boost converter is continuous, and the RMS ripple current at the input is low. Calculate the capacitor value and ESR of the input capacitor using the following equations:

$$C_{IN} = \frac{\Delta I_L}{8 \times f_{SW} \times \Delta V_Q}$$

$$ESR = \frac{\Delta V_{ESR}}{\Delta I_L}$$

Dual, 2.2MHz, Automotive Synchronous Buck Converter with 80V Load-Dump Protection

where

$$\Delta I_L = \frac{(V_{IN} - V_{DS}) \times D}{L \times f_{SW}}$$

where V_{DS} is the voltage drop across the internal MOSFET switch. ΔI_L is the peak-to-peak inductor ripple current as calculated above. ΔV_Q is the portion of input ripple due to the capacitor discharge, and ΔV_{ESR} is the contribution due to ESR of the capacitor.

Output Capacitor

For the boost converter, the output capacitor supplies the load current when the main switch is on. The required output capacitance is high, especially at higher duty cycles. Also, the output capacitor ESR needs to be low enough to minimize the voltage drop due to the ESR while supporting the load current. Use the following equation to calculate the output capacitor for a specified output ripple tolerance:

$$ESR = \frac{\Delta V_{ESR}}{I_{PK}}$$

$$C_{OUT} = \frac{I_O \times D_{MAX}}{\Delta V_Q \times f_{SW}}$$

where I_{PK} is the peak inductor current as defined in the following *Power Dissipation* section, I_O is the load current, ΔV_Q is the portion of the ripple due to the capacitor discharge, and ΔV_{ESR} is the contribution due to the ESR of the capacitor. D_{MAX} is the maximum duty cycle at minimum input voltage.

Power Dissipation

The MAX5099 includes two internal power MOSFET switches. The DC loss is a function of the RMS current in the switch while the switching loss is a function of switching frequency and instantaneous switch voltage and current. Use the following equations to calculate the RMS current, DC loss, and switching loss of each converter. The MAX5099 is available in a thermally enhanced package and can dissipate up to 2.7W at +70°C ambient temperature. The total power dissipation in the package must be limited so that the operating junction temperature does not exceed its absolute maximum rating of +150°C at maximum ambient temperature.

For the buck converter:

$$I_{RMS} = \sqrt{\left(I_{DC}^2 + I_{PK}^2 + (I_{DC} \times I_{PK})\right) \times \frac{D_{MAX}}{3}}$$

$$P_{DC} = I_{RMS}^2 \times R_{ON(MAX)}$$

where

$$I_{DC} = I_O - \frac{\Delta I_L}{2}$$

$$I_{PK} = I_O + \frac{\Delta I_L}{2}$$

$$P_{SW} = \frac{V_{IN} \times I_O \times (t_R + t_F) \times f_{SW}}{4}$$

See the *Electrical Characteristics* table for the $R_{ON(MAX)}$ maximum value.

For the boost converter:

$$I_{RMS} = \sqrt{\left(I_{DC}^2 + I_{PK}^2 + (I_{DC} \times I_{PK})\right) \times \frac{D_{MAX}}{3}}$$

$$I_{IN} = \frac{V_O \times I_O}{V_{IN} \times \eta}$$

$$\Delta I_L = \frac{(V_{IN} - V_{DS}) \times D}{L \times f_{SW}}$$

$$I_{DC} = I_{IN} - \frac{\Delta I_L}{2}$$

$$I_{PK} = I_{IN} + \frac{\Delta I_L}{2}$$

$$P_{DC} = I_{RMS}^2 \times R_{ON(MAX)}$$

where V_{DS} is the drop across the internal MOSFET and η is the efficiency. See the *Electrical Characteristics* table for the $R_{ON(MAX)}$ value.

$$P_{SW} = \frac{V_O \times I_{IN} \times (t_R + t_F) \times f_{SW}}{4}$$

where t_R and t_F are rise and fall times of the internal MOSFET. The t_R and t_F can be measured in the actual application.

The supply current in the MAX5099 is dependent on the switching frequency. See the *Typical Operating Characteristics* to find the supply current of the MAX5099 at a given operating frequency. The power dissipation (P_S) in the device due to supply current (I_{SUPPLY}) is calculated using following equation:

$$P_S = V_{INMAX} \times I_{SUPPLY}$$

The total power dissipation P_T in the device is:

$$P_T = P_{DC1} + P_{DC2} + P_{SW1} + P_{SW2} + P_S$$

where P_{DC1} and P_{DC2} are DC losses in converter 1 and converter 2, respectively. P_{SW1} and P_{SW2} are switching losses in converter 1 and converter 2, respectively.

Dual, 2.2MHz, Automotive Synchronous Buck Converter with 80V Load-Dump Protection

Calculate the temperature rise of the die using the following equation:

$$T_J = T_C \times (P_T \times \theta_{JC})$$

where θ_{JC} is the junction-to-case thermal impedance of the package equal to $+1.7^\circ\text{C/W}$. Solder the exposed pad of the package to a large copper area to minimize the case-to-ambient thermal impedance. Measure the temperature of the copper area near the device at a worst-case condition of power dissipation, and use $+1.7^\circ\text{C/W}$ as θ_{JC} thermal impedance.

Compensation

The MAX5099 provides an internal transconductance amplifier with its inverting input and its output available for external frequency compensation. The flexibility of external compensation for each converter offers wide selection of output filtering components, especially the output capacitor. For cost-sensitive applications, use high-ESR aluminum electrolytic capacitors; for component size-sensitive applications, use low-ESR tantalum, polymer, or ceramic capacitors at the output. The high switching frequency of the MAX5099 allows the use of ceramic capacitors at the output.

Choose all the passive power components that meet the output ripple, component size, and component cost requirements. Choose the small-signal components for the error amplifier to achieve the desired closed-loop bandwidth and phase margin. Use a simple pole-zero pair (Type II) compensation if the output capacitor ESR zero frequency is below the unity-gain crossover frequency (f_C). Type III compensation is necessary when the ESR zero frequency is higher than f_C or when compensating for a continuous-mode boost converter that has a right-half-plane zero.

Use procedure 1 to calculate the compensation network components when $f_{ZERO,ESR} < f_C$.

Buck Converter Compensation

Procedure 1 (See Figure 3)

1) Calculate the $f_{ZERO,ESR}$ and LC double-pole frequencies:

$$f_{ZERO,ESR} = \frac{1}{2\pi \times ESR \times C_{OUT}}$$

$$f_{LC} = \frac{1}{2\pi \sqrt{L_{OUT} \times C_{OUT}}}$$

2) Select the unity-gain crossover frequency:

$$f_C \leq \frac{f_{SW}}{20}$$

If the $f_{ZERO,ESR}$ is lower than f_C and close to f_{LC} , use a Type II compensation network where $R_F C_F$ provides a midband zero $f_{MID,ZERO}$, and $R_F C_{CF}$ provides a high-frequency pole.

3) Calculate modulator gain G_M at the crossover frequency.

$$G_M = \frac{V_{IN}}{V_{OSC}} \times \frac{ESR}{ESR + (2\pi \times f_C \times L_{OUT})} \times \frac{0.8}{V_{OUT}}$$

where V_{OSC} is a peak-to-peak ramp amplitude equal to 1V.

The transconductance error-amplifier gain is:

$$G_{E/A} = g_M \times R_F$$

The total loop gain at f_C should be equal to 1:

$$G_M \times G_{E/A} = 1$$

or

$$R_F = \frac{V_{OSC} (ESR + 2\pi \times f_C \times L_{OUT}) \times V_{OUT}}{0.8 \times V_{IN} \times g_M \times ESR}$$

4) Place a zero at or below the LC double-pole:

$$C_F = \frac{1}{2\pi \times R_F \times f_{LC}}$$

5) Place a high-frequency pole at $f_p = 0.5 \times f_{SW}$.

$$C_{CF} = \frac{C_F}{(2\pi \times 0.5 f_{SW} \times R_F \times C_F) - 1}$$

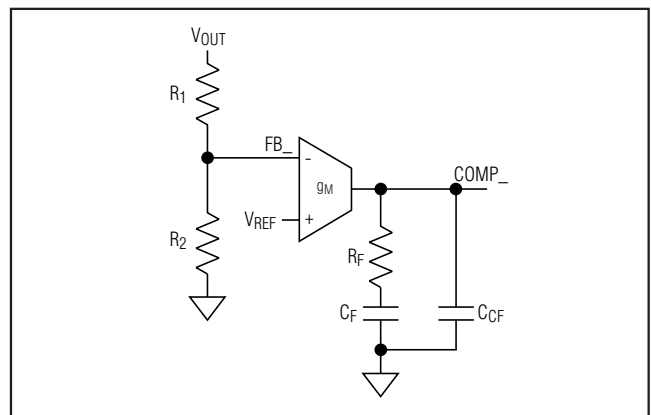

Figure 3. Type II Compensation Network

Dual, 2.2MHz, Automotive Synchronous Buck Converter with 80V Load-Dump Protection

Procedure 2 (See Figure 4)

If the output capacitor used is a low-ESR ceramic type, the ESR frequency is usually far away from the targeted unity crossover frequency (f_C). In this case, Type III compensation is recommended. Type III compensation provides two-pole zero pairs. The locations of the zero and poles should be such that the phase margin peaks around f_C . It is also important to place the two zeros at or below the double pole to avoid the conditional stability issue.

1) Select a crossover frequency:

$$f_{SW} \leq \frac{f_{SW}}{20}$$

2) Calculate the LC double-pole frequency, f_{LC} :

$$f_{LC} = \frac{1}{2\pi \times \sqrt{L_{OUT} \times C_{OUT}}}$$

3) Place a zero $f_{Z1} = \frac{1}{2\pi \times R_F \times C_F}$ at $0.75 \times f_{LC}$.

where

$$C_F = \frac{1}{2\pi \times 0.75 \times f_{LC} \times R_F}$$

and $R_F \geq 10k\Omega$.

4) Calculate C_1 for a target unity crossover frequency, f_C .

$$C_1 = \frac{2\pi \times f_C \times L_{OUT} \times C_{OUT} \times V_{OSC}}{V_{IN} \times R_F}$$

5) Place a pole $f_{p1} = \frac{1}{2\pi \times R_1 \times C_1}$ at $f_{ZERO,ESR}$.

$$R_1 = \frac{1}{2\pi \times f_{ZERO,ESR} \times C_1}$$

6) Place a second zero, f_{Z2} , at $0.2 \times f_C$ or at f_{LC} , whichever is lower.

$$R1 = \frac{1}{2\pi \times f_{Z2} \times C_1} - R_1$$

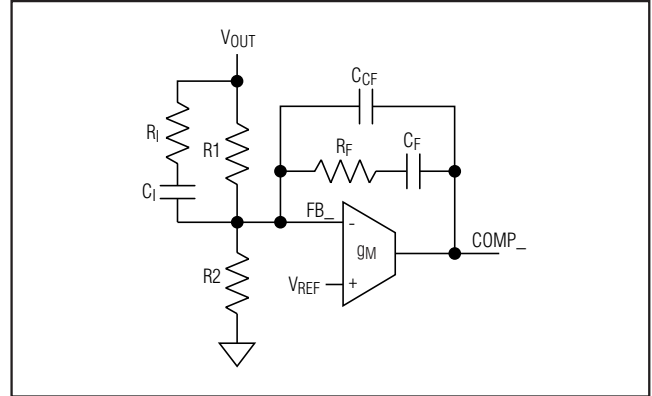

Figure 4. Type III Compensation Network

7) Place a second pole at 1/2 the switching frequency.

$$C_{CF} = \frac{C_F}{(2\pi \times 0.5 \times f_{SW} \times R_F \times C_F) - 1}$$

Boost Converter Compensation

The boost converter compensation gets complicated due to the presence of a right-half-plane zero $f_{ZERO,RHP}$. The right-half-plane zero causes a drop in phase while adding positive (+1) slope to the gain curve. It is important to drop the gain significantly below unity before the RHP frequency. Use the following procedure to calculate the compensation components:

1) Calculate the LC double-pole frequency, f_{LC} , and the right-half-plane-zero frequency.

$$f_{LC} = \frac{1-D}{2\pi \times \sqrt{L_{OUT} \times C_{OUT}}}$$

$$f_{ZERO,RHP} = \frac{(1-D)^2 R_{(MIN)}}{2\pi \times L_{OUT}}$$

where

$$D = 1 - \frac{V_{OUT}}{V_{IN}}$$

$$R_{(MIN)} = \frac{V_{OUT}}{I_{OUT(MAX)}}$$

Target the unity-gain crossover frequency for:

$$f_C \leq \frac{f_{ZERO,RHP}}{5}$$

Dual, 2.2MHz, Automotive Synchronous Buck Converter with 80V Load-Dump Protection

2) Place a zero $f_{Z1} = \frac{1}{2\pi \times R_F \times C_F}$ at $0.75 \times f_{LC}$.

$$C_F = \frac{1}{2\pi \times 0.75 \times f_{LC} \times R_F}$$

where $R_F \geq 10k\Omega$.

3) Calculate C_1 for a target crossover frequency, f_C :

$$C_1 = \frac{V_{OSC} \left[(1-D)^2 + \omega_C^2 L_O C_O \right]}{\omega_C R_F V_{IN}}$$

where $\omega_C = 2\pi \times f_C$.

4) Place a pole $f_{P1} = \frac{1}{2\pi \times R_1 \times C_1}$ at $f_{ZERO,RHP}$

or $5 \times f_C$, whichever is lower.

$$R_1 = \frac{1}{2\pi \times f \times C_1}$$

5) Place the second zero $f_{Z2} = \frac{1}{2\pi \times R_1 \times C_1}$ at f_{LC} .

$$R_1 = \frac{1}{2\pi \times f_{LC} \times C_1} - R_1$$

6) Place the second pole at 1/2 the switching frequency.

$$C_{CF} = \frac{C_F}{(2\pi \times 0.5 \times f_{SW} \times R_F \times C_F) - 1}$$

Load-Dump Protection MOSFET

Select the external MOSFET with an adequate voltage rating, V_{DSS} , to withstand the maximum expected load-dump input voltage. The on-resistance of the MOSFET, $R_{DS(ON)}$, should be low enough to maintain a minimal voltage drop at full load, limiting the power dissipation of the MOSFET.

During regular operation, the power dissipated by the MOSFET is:

$$P_{NORMAL} = I_{LOAD}^2 \times R_{DS(ON)}$$

where I_{LOAD} is equal to the sum of both converters' input currents.

The MOSFET operates in a saturation region during load dump, with both high voltage and current applied.

Choose a suitable power MOSFET that can safely operate in the saturation region. Verify its capability to support the downstream DC-DC converters' input current during the load-dump event by checking its safe operating area (SOA) characteristics.

Since the transient peak power dissipation on the MOSFET can be very high during the load-dump event, also refer to the thermal impedance graph given in the data sheet of the power MOSFET to make sure its transient power dissipation is kept within the recommended limits.

Improving Noise Immunity

In applications where the MAX5099 is subject to noisy environments, adjust the controller's compensation to improve the system's noise immunity. In particular, high-frequency noise coupled into the feedback loop causes jittery duty cycles. One solution is to lower the crossover frequency (see the *Compensation* section).

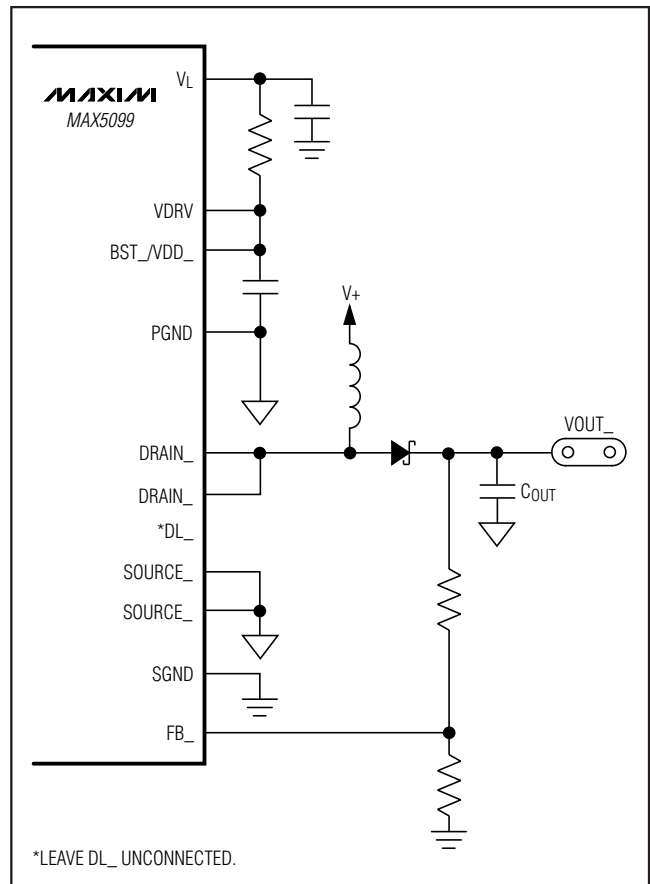

Figure 5. Boost Application

Dual, 2.2MHz, Automotive Synchronous Buck Converter with 80V Load-Dump Protection

PCB Layout Guidelines

Careful PCB layout is critical to achieve low switching losses and clean, stable operation. This is especially true for dual converters where one channel can affect the other. Refer to the MAX5098A/MAX5099 Evaluation Kit data sheet for a specific layout example. Use a multilayer board whenever possible for better noise immunity. Follow these guidelines for good PCB layout:

- 1) For SGND, use a large copper plane under the IC and solder it to the exposed paddle. To effectively use this copper area as a heat exchanger between the PCB and ambient, expose this copper area on the top and bottom side of the PCB. Do not make a direct connection from the exposed pad copper plane to SGND underneath the IC.
- 2) Isolate the power components and high-current path from the sensitive analog circuitry.
- 3) Keep the high-current paths short, especially at the ground terminals. This practice is essential for stable, jitter-free operation.
- 4) Connect SGND and PGND together at a single point. Do not connect them together anywhere else (refer to the MAX5099 Evaluation Kit data sheet for more information).
- 5) Keep the power traces and load connections short. This practice is essential for high efficiency. Use thick copper PCBs (2oz vs. 1oz) to enhance full-load efficiency.
- 6) Ensure that the feedback connection to C_{OUT} is short and direct.
- 7) Route high-speed switching nodes (BST__{VDD}_, SOURCE_) away from the sensitive analog areas (BYPASS, COMP_, and FB_). Use the internal PCB layer for SGND as an EMI shield to keep radiated noise away from the IC, feedback dividers, and analog bypass capacitors.

Layout Procedure

- 1) Place the power components first, with ground terminals adjacent (inductor, C_{IN}_, and C_{OUT}_). Make all these connections on the top layer with wide, copper-filled areas (2oz copper recommended).
- 2) Group the gate-drive components (bootstrap diodes and capacitors, and V_L bypass capacitor) together near the controller IC.
- 3) Make the DC-DC controller ground connections as follows:
 - a) Create a signal ground plane underneath the IC.
 - b) Connect this plane to SGND and use this plane for the ground connection for the reference (BYPASS), enable, compensation components, feedback dividers, and OSC resistor.
 - c) Connect SGND and PGND together (this is the only connection between SGND and PGND). Refer to the MAX5098A/MAX5099 Evaluation Kit data sheet for more information.

Dual, 2.2MHz, Automotive Synchronous Buck Converter with 80V Load-Dump Protection

MAX5099

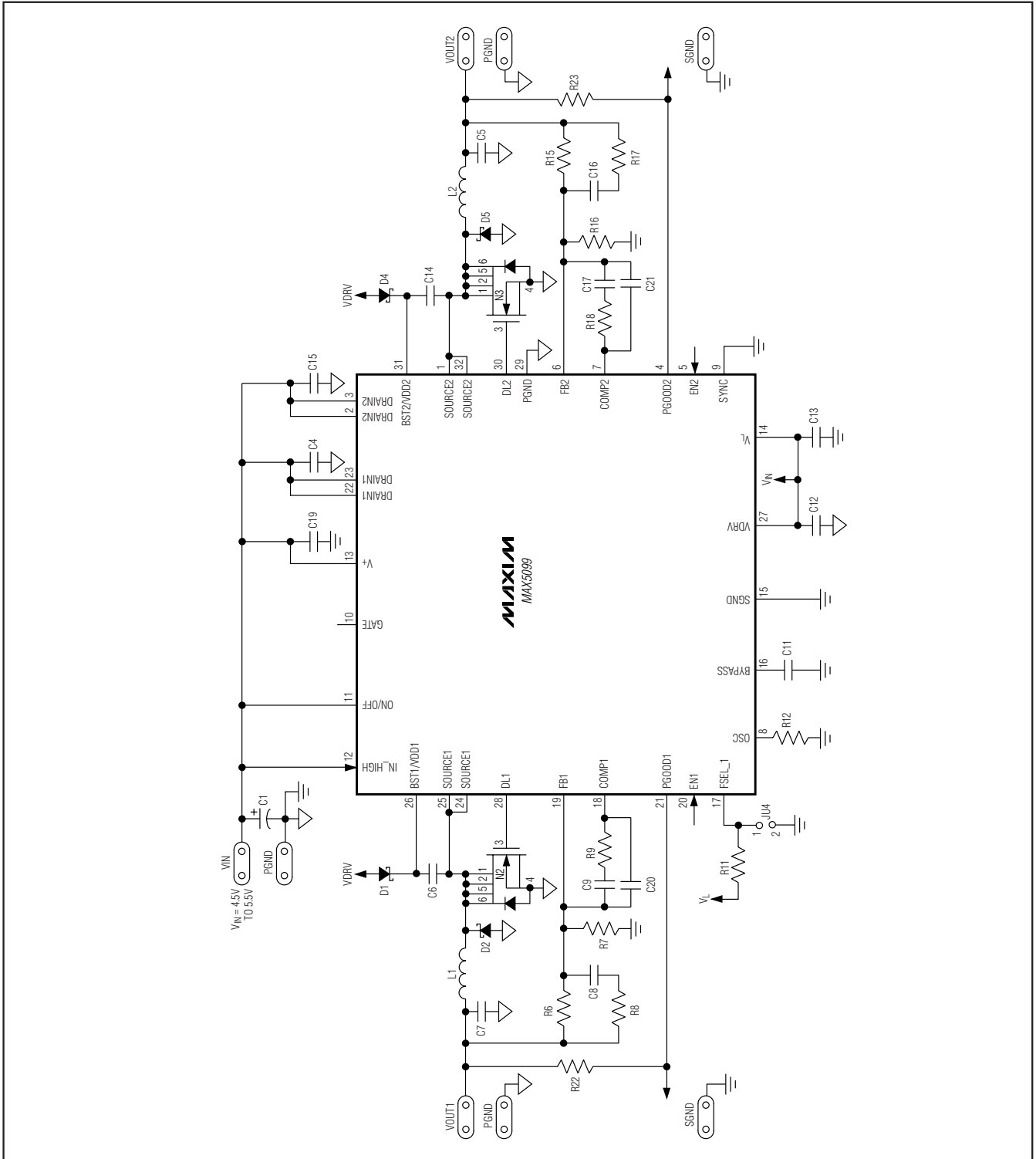
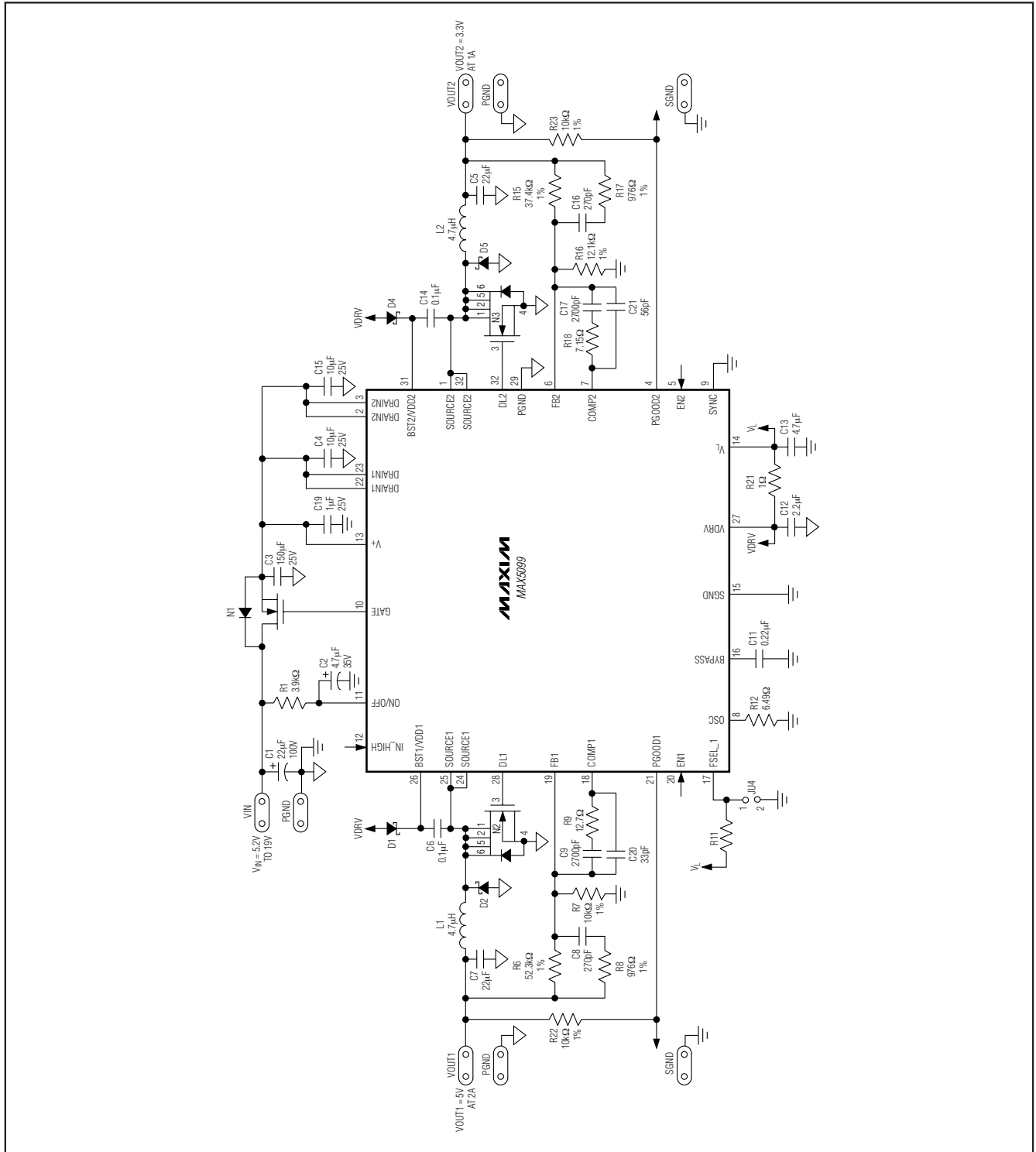

Figure 6. 4.5V to 5.5V Operation

Dual, 2.2MHz, Automotive Synchronous Buck Converter with 80V Load-Dump Protection

Typical Application Circuit



Dual, 2.2MHz, Automotive Synchronous Buck Converter with 80V Load-Dump Protection

MAX5099

Pin Configuration

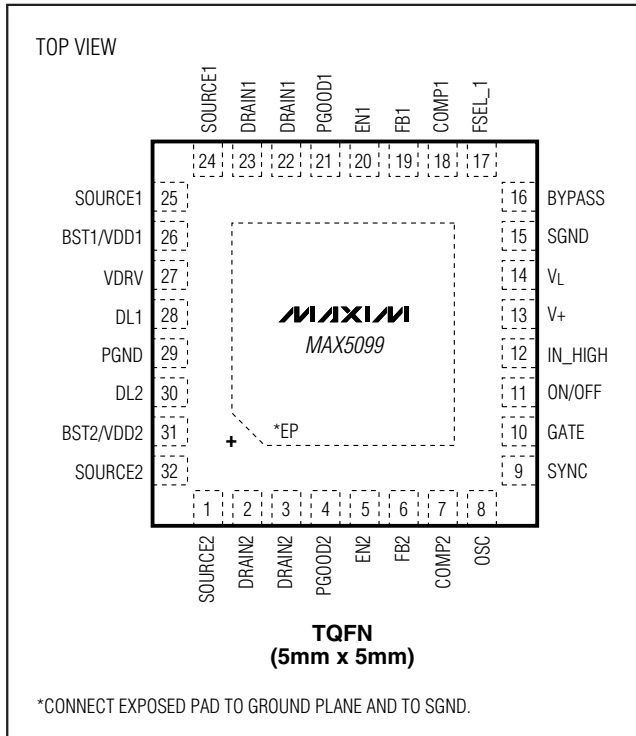

Chip Information

PROCESS: BiCMOS

Package Information

For the latest package outline information, go to www.maxim-ic.com/packages.

PACKAGE TYPE	PACKAGE CODE	DOCUMENT NO.
32 TQFN	T3255+4	21-0140

Maxim cannot assume responsibility for use of any circuitry other than circuitry entirely embodied in a Maxim product. No circuit patent licenses are implied. Maxim reserves the right to change the circuitry and specifications without notice at any time.

Maxim Integrated Products, 120 San Gabriel Drive, Sunnyvale, CA 94086 408-737-7600 _____ 27